

Xterio

| Cornice, Brackets & Dentils

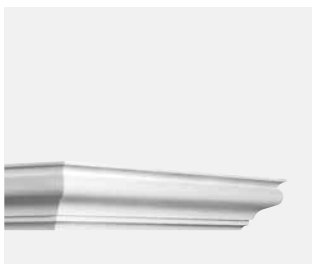

Cornices



C800 2

2000 x 65 x 57 mm
Purotouch®



C833

2000 x 122 x 111 mm
Purotouch®

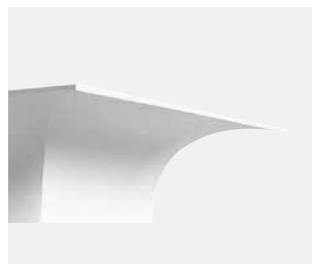
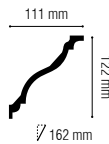

C890

2000 x 159 x 216 mm
Purotouch®

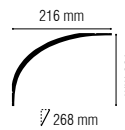

C843 HERITAGE XL

2000 x 190 x 250 mm
Purotouch®

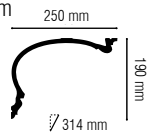

C835

200 x 202 x 222 mm
Purotouch®

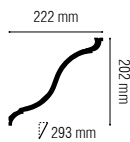

C832 1

2000 x 230 x 114 mm
Purotouch®

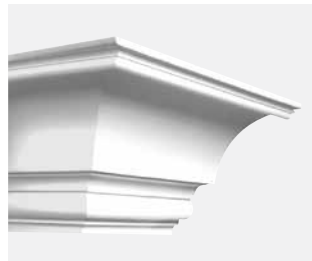
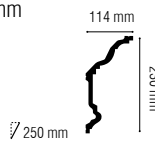

C836 front

2000 x 271 x 266 mm
Purotouch®

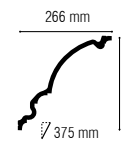

C844 HERITAGE XXL

2000 x 273 x 350 mm
Purotouch®

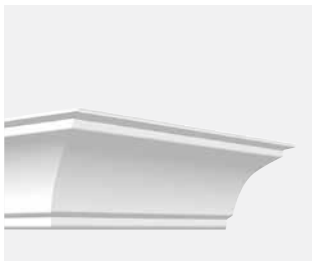
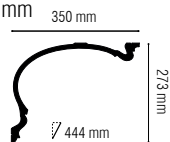

C820 3

2000 x 160 x 200 mm
Purotouch®

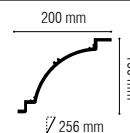

Finishing elements to suit C820



C820A 3a

Outer corner 90°

C820B 3b

Inner corner 90°

C820C

Outer corner 135°

C820D

Inner corner 135°

C820E

Stop end left

C820F

Stop end right

C820G 3c

Mitre stop end

Brackets

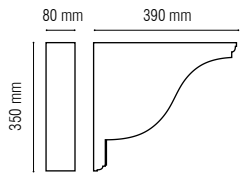

FC01 4

80 x 350 x 390 mm
Purotouch®

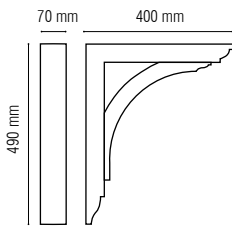

GB02 *

70 x 490 x 400 mm
Purotouch®
Structural max. 35 kg

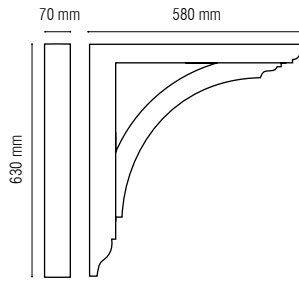

GB03 * 5

70 x 630 x 580 mm
Purotouch®
Structural max. 75 kg

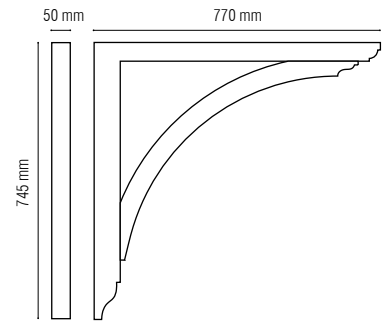

GB04 * 6

50 x 745 x 770 mm
Purotouch®
Structural max. 75 kg

*white wood grain finish

Dentils



TF01

77 x 123 x 350 mm
Purotouch®



TF02

77 x 120 x 105 mm
Purotouch®



TF03 7

77 x 100 x 200 mm
Purotouch®



TF04 8

77 x 200 x 250 mm
Purotouch®

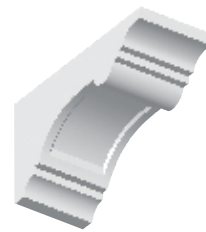

TF05 9

100 x 135 x 255 mm
Purotouch®

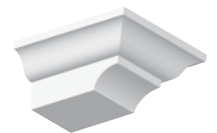

TF06

155 x 75 x 175 mm
Purotouch®

Rafter Foot

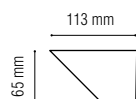

RF01 10

48 x 65 x 113 mm
with unique click system
Purotouch®

Installation

| of the Xterio Collection



Ask for a free
new **Orac Decor Book**
and samples on:
www.oracdecor.com



**DecoFix Hydro
FDP700**

Gluing on wall and ceiling
290 ml for 7 to 8 m



Extra strong MS polymer glue for exterior applications, non-porous (tiles, glass, ...) surfaces and damp environments

- Remove with soap solution
- Paintable after hardening (min. 24 hrs.)



**DecoFix Extra
FX200**

Joints
310 ml for min. 80 m



Polyurethane-based glue to seam joints between mouldings

- Remove excess glue before hardening (max. 1 hour and repeat after 2-3 hrs.)
- Clean with acetone or synthetic thinner
- Can be painted after 24 hrs.
- The more humidity, the faster the drying time

+

ONLY FULL GUARANTEE WITH DECOFIX

Benefits

| of the Xterio Collection



UV STABLE
NO DISCOLORATION



BRITAIN'S TOP
DENTIL SUPPLIER



NO NEED TO BUY
IN PACK QUANTITIES

ITEMS IN STOCK FOR
IMMEDIATE DISPATCH

Discover also

| Our Interior Solutions



Contact

| Dealer Information



More information on www.oracdecor.com